

## 3U CompactPCI EN50155 8-port managed Gigabit Ethernet switch with 8x10/100/1000Base-T(X) in CompactPCI socket

### Features

- Leading EN50155 compliant Ethernet switch for rolling stock application
- Supports 3U and 4HP CompactPCI form factor and hot swapping
- PICMG 2.0 specification compatible
- Support 8x10/100/1000Base-T(X) ports in CompactPCI sockets
- Support Jumbo frame up to 9.6K Bytes
- Supports O-Ring (recovery time < 30ms over 250 units of connection), MSTP/RSTP/STP (IEEE 802.1s/w/D) for Ethernet Redundancy
- Open-Ring support the other vendor's ring technology in open architecture
- O-Chain allow multiple redundant network rings
- Support standard IEC 62439-2 MRP (Media Redundancy Protocol) function
- Supports IPV6 new internet protocol version
- Support Modbus TCP protocol
- Support IEEE 802.3az Energy-Efficient Ethernet technology
- Provided HTTPS/SSH protocol to enhance network security
- Supports SMTP client
- Supports IP-based bandwidth management
- Supports application-based QoS management
- Supports Device Binding security function
- Supports DOS/DDOS auto prevention
- Supports SSH/Https security function
- IGMP v2/v3 (IGMP snooping support) for filtering multicast traffic
- Supports SNMP v1/v2c/v3, RMON and 802.1Q VLAN Network Management
- Support ACL, TACACS+ and 802.1x User Authentication for security
- Multiple notification for warning of unexpected event
- Windows utility (Open-Vision) support centralized management and configurable by Web-based interface, Telnet and Console (CLI)
- Support LLDP Protocol
- Support hot-swappable technology



### Introduction

ORing's CompactPCI series Ethernet switches are designed for industrial applications, such as factory automation, vehicle, and railway applications. CPGS-9080-C is CompactPCI managed redundant ring Ethernet switch with 8x10/100/1000Base-T(X) ports in CompactPCI socket which is specifically designed for the toughest and fully compliant with EN50155 requirement. The switch support Ethernet Redundancy protocol, O-Ring (recovery time < 30ms over 250 units of connection) and MSTP (RSTP/STP compatible) can protect your mission-critical applications from network interruptions or

temporary malfunctions with its fast recovery technology. CPGS-9080-C supports wide operating temperature from -40 °C to 70 °C which can fulfill most of the requirement of operation environment. Except the Web-based interface, Telnet and console (CLI) configuration, CPGS-9080-C can also be managed centralized and conveniently by Open-Vision. Therefore, the switch is one of the most reliable choices for rolling stock and highly-managed Ethernet application.

- **O-Ring** : O-Ring is ORing's proprietary redundant ring technology, with recovery time of less 30 milliseconds and up to 250 nodes. The O-Ring redundant ring technology can protect mission-critical application from network interruptions or temporary malfunction with its fast recover technology.
- **Open-Ring** : Open-Ring is an enhanced redundant technology that makes ORing's switches compatible with other vendor's proprietary redundant ring technologies. It enables ORing's switches to form a single ring with other vendor's switch. In cases where the ring is setup using proprietary technology, ORing offers a compatibility service where ORing can make its switches compatible with your particular network requirements.
- **O-Chain** : O-Chain is the revolutionary network redundancy technology that provides the add-on network redundancy topology for any backbone network, O-Chain allows multiple redundant network rings of different redundancy protocols to join and function together as a larger and more robust compound network topology. O-Chain providing ease-of-use while maximizing fault-recovery swiftness, flexibility, compatibility, and cost-effectiveness in one set of network redundancy topology.
- **MRP** : Media Redundancy Protocol (MRP) is a data network protocol standardized by the IEC 62439-2. It allows rings of Ethernet switches to overcome any single failure with recovery time much faster than achievable with Spanning Tree Protocol.
- **IP-based Bandwidth Management** : The switch provide advanced IP-based bandwidth management which can limit the maximum bandwidth for each IP device. User can configure IP camera and NVR with more bandwidth and limit other device bandwidth.
- **Application-Based QoS** : The switch also support application-based QoS. Application-based QoS can set highest priority for data stream according to TCP/UDP port number.
- **Device Binding Function** : ORing special Device Binding function can only permit allowed IP address with MAC address to access the network. Hacker cannot access the IP surveillance network without permission. It can avoid hacker from stealing video privacy data and attacking IP camera, NVR and controllers.
- **Advanced DOS/DDOS Auto Prevention** : The switch also provided advanced DOS/DDOS auto prevention. If there is any IP flow become big in short time, the switch will lock the source IP address for certain time to prevent the attack. It's hardware based prevention so it can prevent DOS/DDOS attack immediately and completely.
- **Modbus TCP** : This is a Modbus variant used for communications over TCP/IP networks.
- **IEEE 802.3az Energy-Efficient Ethernet** : This is a set of enhancements to the twisted-pair and backplane Ethernet family of networking standards that will allow for less power consumption during periods of low data activity. The intention was to reduce power consumption by 50% or more.

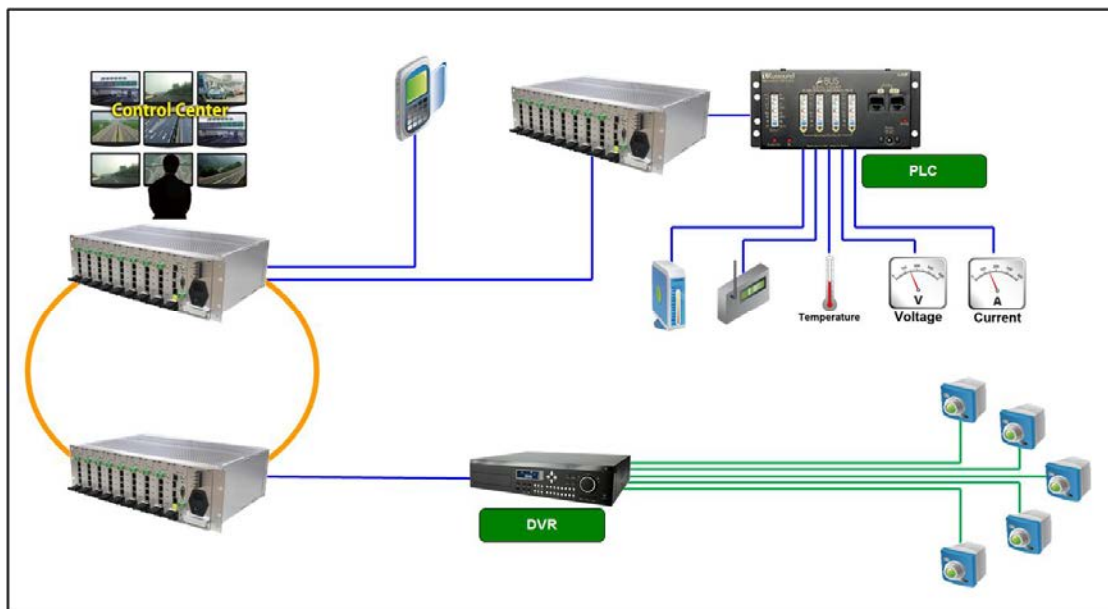

*Network connection*

## Open-Vision

ORing's switches are intelligent switches. Different from other traditional redundant switches, ORing provides a set of Windows utility (Open-Vision) for user to manage and monitor all of industrial Ethernet switches on the industrial network.

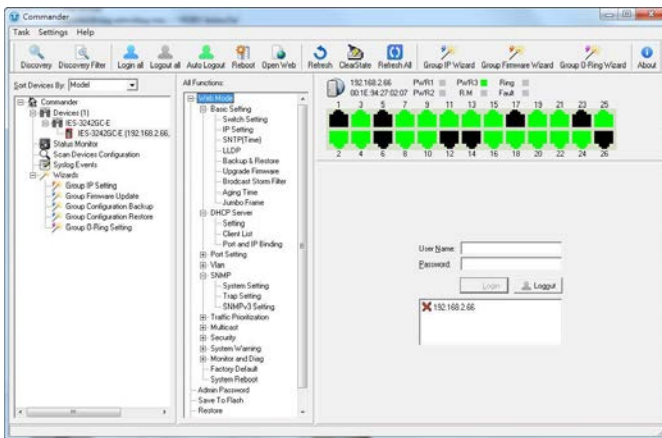

*Commander*

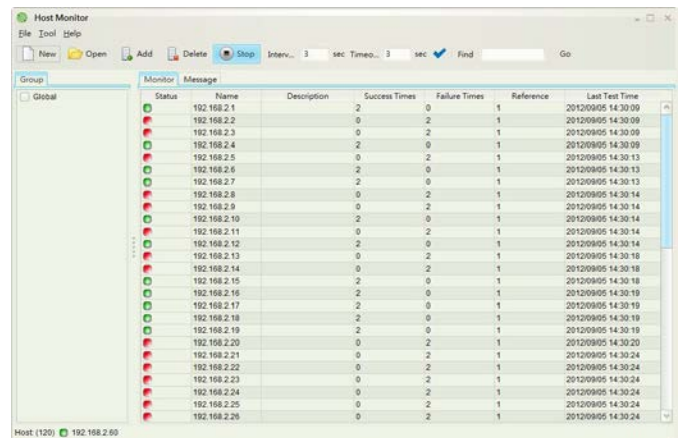

*Host Monitor*

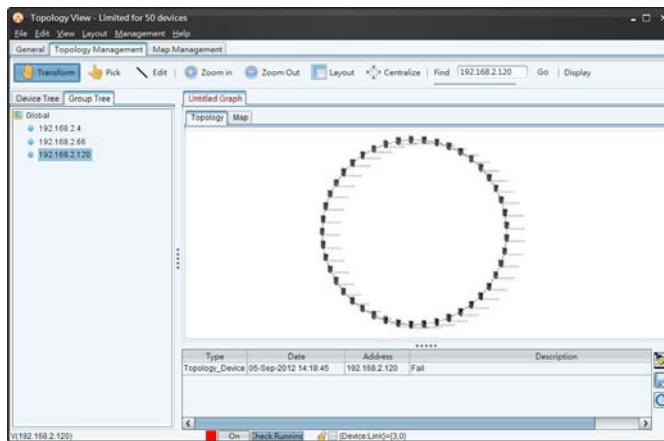

*Topology View*

## I/O Functional

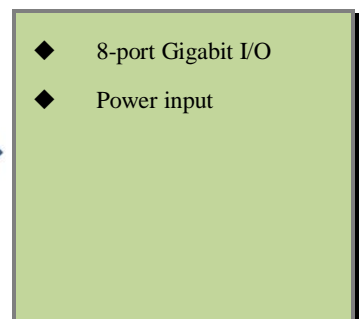
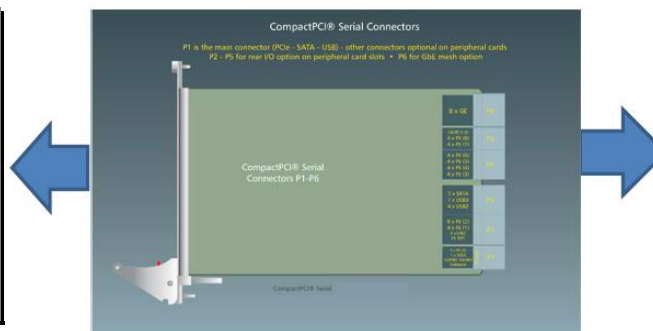
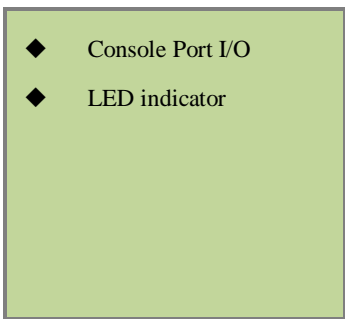

# Specifications

ORing Switch Model	CPGS-9080-C
<b>Physical Ports</b>	
10/100/1000Base-T(X) Ports Auto MDI/MDIX	8-port with CompactPCI interface (PICMG 2.0 compatible)
<b>Technology</b>	
Ethernet Standards	<p>IEEE 802.3 for 10Base-T</p> <p>IEEE 802.3u for 100Base-TX</p> <p>IEEE 802.3ab for 1000Base-T</p> <p>IEEE 802.3x for Flow control</p> <p>IEEE 802.3ad for LACP (Link Aggregation Control Protocol )</p> <p>IEEE 802.1D for STP (Spanning Tree Protocol)</p> <p>IEEE 802.1p for COS (Class of Service)</p> <p>IEEE 802.1Q for VLAN Tagging</p> <p>IEEE 802.1w for RSTP (Rapid Spanning Tree Protocol)</p> <p>IEEE 802.1s for MSTP (Multiple Spanning Tree Protocol)</p> <p>IEEE 802.1x for Authentication</p> <p>IEEE 802.1AB for LLDP (Link Layer Discovery Protocol)</p>
MAC Table	8k
Priority Queues	8
Processing	Store-and-Forward
Switch Properties	<p>Switching latency: 7 us</p> <p>Switching bandwidth: 16Gbps</p> <p>Max. Number of Available VLANs: 4096</p> <p>IGMP multicast groups: 128 for each VLAN</p> <p>Port rate limiting: User Define</p>
Jumbo frame	Up to 9.6K Bytes
Security Features	<p>Device Binding security feature</p> <p>Enable/disable ports, MAC based port security</p> <p>Port based network access control (802.1x)</p> <p>VLAN (802.1Q ) to segregate and secure network traffic</p> <p>Radius centralized password management</p> <p>SNMPv3 encrypted authentication and access security</p> <p>Https / SSH enhance network security</p>
Software Features	<p>STP/RSTP/MSTP (IEEE 802.1D/w/s)</p> <p>Redundant Ring (O-Ring) with recovery time less than 30ms over 250 units</p> <p>TOS/Diffserv supported</p> <p>Quality of Service (802.1p) for real-time traffic</p> <p>VLAN (802.1Q) with VLAN tagging and GVRP supported</p> <p>IGMP Snooping</p> <p>IP-based bandwidth management</p> <p>Application-based QoS management</p> <p>DOS/DDOS auto prevention</p> <p>Port configuration, status, statistics, monitoring, security</p> <p>DHCP Server/Client/Relay</p> <p>SMTP Client</p> <p>Modbus TCP</p>
Network Redundancy	<p>O-Ring</p> <p>Open-Ring</p> <p>O-Chain</p> <p>MRP</p> <p>MSTP ( STP / RSTP compatible)</p>
RS-232 Serial Console Port	RS-232 in RJ45 connector with console cable. 115200bps, 8, N, 1
<b>LED Indicators</b>	
Power indicator (Power)	Green : Power LED x 1
Status Indicator (STA)	Green : Ethernet status indicator
R.M. indicator (R.M)	Green : Indicate system operated in O-Ring Master mode
Ring indicator (Ring)	Green : Indicate system operated in O-Ring mode
Fault indicator (Fault)	Amber : Indicate unexpected event occurred
10/100/1000Base-T(X) port indicator	Green for port Link/Act.

Power	
Power Input	CompactPCI bus powered (12VDC)
Power Consumption (Typ.)	6.2Watts
Overload Current Protection	Present
Physical Characteristic	
Dimension (W x D x H)	20 (W) x 209 (D) x 130.7 (H)mm (0.79 x 8.23 x 5.15 inch)
Weight (g)	224g
Environmental	
Storage Temperature	-40 to 85°C (-40 to 185°F)
Operating Temperature	-40 to 70°C (-40 to 158°F)
Operating Humidity	5% to 95% Non-condensing
Regulatory Approvals	
EMI	FCC Part 15, CISPR (EN55022) class A, EN50155 (EN50121-3-2, EN55011, EN50121-4)
EMS	EN61000-4-2 (ESD), EN61000-4-3 (RS), EN61000-4-4 (EFT), EN61000-4-5 (Surge), EN61000-4-6 (CS), EN61000-4-8, EN61000-4-11
Shock	IEC60068-2-27
Free Fall	IEC60068-2-32
Vibration	IEC60068-2-6
Safety	EN60950-1
Warranty	5 years

## Ordering Information

CPGS-9 **AAB-C**

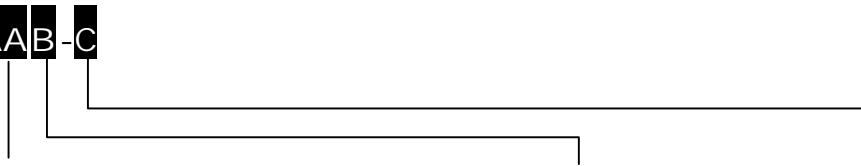

Code Definition	10/100/1000Base-T(X) Port Number	Additional Port Number	CompactPCI Version
<b>Option</b>	<b>- 08:</b> 8 ports	<b>- 0:</b> 0 port	<b>- C :</b> PICMG 2.0 specification

Available Model	Model Name	Description
	<b>CPGS-9080-C</b>	3U CompactPCI EN50155 8-port managed Gigabit Ethernet switch with 8x10/100/1000Base-T(X)

## Packing List

- CP GS-9080-C x 1
- ORing Tool CD x 1
- Quick Installation Guide x 1
- Console Cable x 1

## Optional Accessories

---

- Open-Vision M500 : Powerful Network Management Windows Utility Suit, 500 IP devices