

Bay Trail Slim DIN Rail PC

Embedded Automation Controller

IBDRW100-EX



Feature

- Design for Industrial Automation, DIN Rail application
- Onboard Intel Celeron Quad-Core N2930 2.16GHz
- 1 x DDR3L SODIMM slot, max. 8GB
- 1 x RS232 / 422 / 485 communication, switch by jump
- 4 x Giga LAN, 1 x USB 3.0, 3 x USB 2.0, 1 x VGA, 1 x Line out, 1 x Power Jack
- Fanless, High efficiency thermal design
- ATEX & C1D2 Certification*

*This device is required to be mounted in ATEX certified or IECEx certified IP54 Enclosure to meet ATEX and C1D2 certification

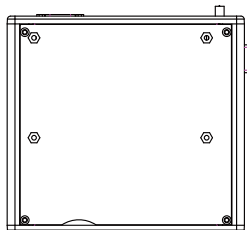
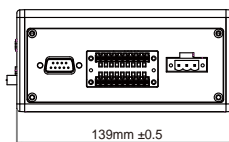
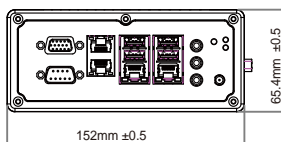
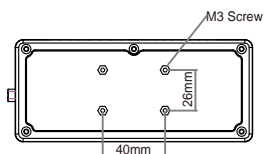
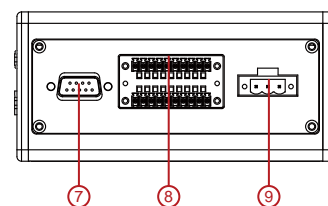
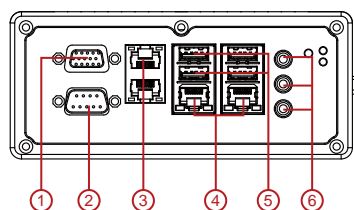
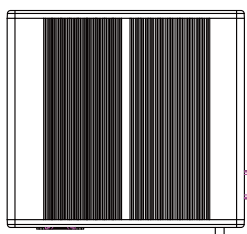

1. VGA
2. RS232 / 422 / 485
3. LAN
4. LAN
5. USB
6. Audio Jack
7. RS232 / Isolated RS422 or 485
8. DIDO
9. Power Terminal Block (9-36V DC in)

Certification

Class1, Division2, Group A, B, C, D
 Temperature Code T4A
 Ambient Temperature: -20°C < Tamb < 60°C
 UL508

ATEX II 3 G Ex nA IIC T4 Gc

I/O Connectors

Front Side I/O : 1 x Power ON/OFF button with LED indicator
 1 x Line Out, Line In, Mic In
 4 x RJ-45 (Giga LAN)
 1 x RS232/422/485 (Switch by jump)
 1 x VGA
 1 x USB3.0
 3 x USB2.0
 1 x DC Power 3pin Terminal Block
 1 x RS232/485 (Isolation)
 1 x 20 pins terminal block DIDO (9in / 9out)

System Specification

Processor : Intel® Celeron® Bay Trail-M N2930 2.16GHz
 System Chipset : Bay Trail SoC Chipset
 System Memory : 1 x DDR3L 1333MHz SO-DIMM, Default 4GB, Max. up to 8GB
 Ethernet Controller : Intel® WG82574L GbE LAN
 USB : 1 x USB 3.0, 3 x USB 2.0 (external)
 2 x USB 2.0 by pin-header (internal)
 Storage : Default 64GB mSATA SSD
 Second Storage(Optional) : 64GB to 256GB 2.5" SSD

Mechanical and Power

Dimensions : 139mm x 65.4mm x 152mm(L x W x H)
 Construction : Metal housing
 Power Input : 9-36V DC IN (Isolation)
 Power Consumption : 25W max.
 Mounting : DIN Rail

Operating System (Option)

Windows Embedded Standard 7
 Windows 7 PRO for Embedded system
 Windows Embedded 8 Standard
 Windows Embedded 8.1 Industrial

Environment Considerations

Operating Temperature : -20 to 60 deg.C
 Storage Temperature : -40 to 80 deg.C
 Operating Humidity : 5% to 95% (non condensing)
 Anti-Vibration : 5Hz~500Hz / 1Grms/3 Axis
 Anti Shock : 15G, 11ms duration

Optional Ordering Information

Second Storage : Option 64GB to 256GB 2.5" SSD
 Memory : Option to 8GB
 Operating System

Note: All Specifications are subject to change without prior notice!

Bay Trail Slim DIN Rail PC

Embedded Automation Controller

IBDRW100-EX

Accessories List

- AC to DC 12V 36W Power Adapter
- DIN Rail Mounting Clip
- Terminal Block 3pin to 2.5 Ø female adapter cable
- Terminal Block 10pin female connector for DIDO x2
- User Manual
- Driver CD
- Power Cable
- Cable Holder Kit



AC to DC 12V 36W Power Adapter



Terminal Block 10pin female connector for DIDO x2



Power Cable



Terminal Block 3pin to 2.5 Ø female adapter cable



User Manual

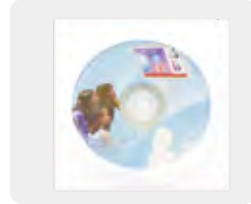

Driver CD

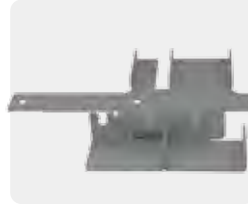

Cable Holder Kit



DIN Rail Mounting Clip

Cable Holder Kit Concept

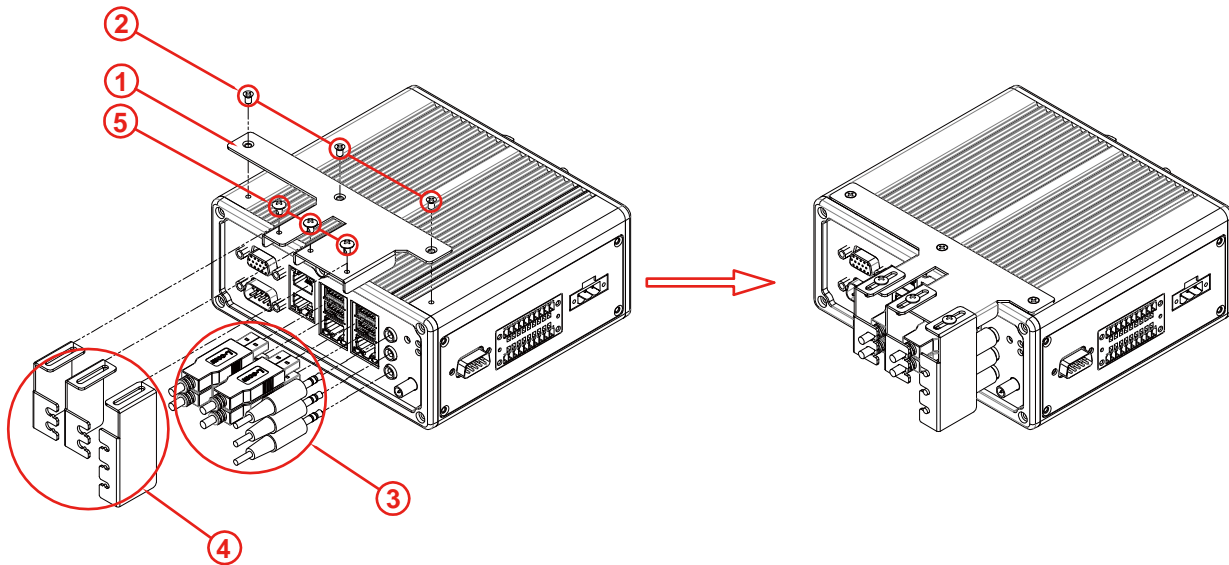

Find the cable arm bracket in the package, including the plate, bracket / holder, and screws

1-2. Install the plate on the top of the box and screw it tightly

3. Plug all the necessary cables into the connectors

4. Place the cable arm bracket according to the picture and then attach the bracket / holders to the plate

5. Fasten it for securing the installed cables

Protection Enclosure (Supply by Customer)

Mount the IBDRW100 in ATEX or IECEx certified IP54 Enclosure for HazLoc. deployment

